

OWNER'S INSTRUCTION MANUAL

It is of vital importance, before attempting to operate your engine, to read the general **'SAFETY INSTRUCTIONS AND WARNINGS'** section on pages 2-5 of this booklet and to strictly adhere to the advice contained therein.

Also, please study the entire contents of this instruction manual, so as to familiarize yourself with the controls and other features of the engine.

Keep these instructions in a safe place so that you may readily refer to them whenever necessary.

It is suggested that any instructions supplied with the vehicle, radio control equipment, etc., are accessible for checking at the same time.

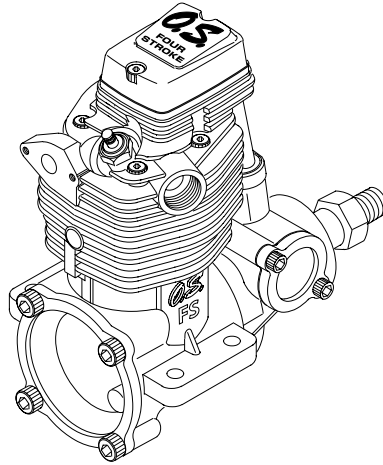
**CONTENTS**

SAFETY INSTRUCTIONS AND WARNINGS		
ABOUT YOUR O.S. ENGINE, NOTES WHEN		
APPLYING AN ELECTRIC STARTER -----	2-6	
INTRODUCTION -----	7	
BEFORE STARTING,		
BASIC ENGINE PARTS -----	8-9	
GLOWPLUG,		
AIR CLEANER TYPE 102S -----	10-11	
INSTALLATION OF THE CARBURETOR &		
HYPER EXHAUST GASKET,		
INSTALLATION -----	12-13	
STARTING THE ENGINE & RUNNING-IN		
('Breaking-in'), VALVE ADJUSTING -----	14-18	
CARE & MAINTENANCE,		
PARTS REPLACEMENT -----	19	
		TROUBLE SHOOTING ----- 20-23
		ENGINE EXPLODED VIEW
		& PARTS LIST ----- 24-25
		CARBURETOR EXPLODED VIEW
		& PARTS LIST ----- 26
		O.S. GENUINE PARTS &
		ACCESSORIES ----- 27-28
		THREE VIEW DRAWING ----- 29
		MEMO ----- 30

SAFETY INSTRUCTIONS AND WARNINGS ABOUT YOUR O.S. ENGINE

Remember that your engine is not a "toy", but a highly efficient internal-combustion machine whose power is capable of harming you, or others, if it is misused.

As owner, you, alone, are responsible for the safe operation of your engine, so act with discretion and care at all times.

If at some future date, your O.S. engine is acquired by another person, we would respectfully request that these instructions are also passed on to its new owner.

- The advice which follows applies basically to ALL MODEL ENGINES and is grouped under two headings according to the degree of damage or danger which might arise through misuse or neglect.



WARNINGS

These cover events which might involve serious (in extreme circumstances, even fatal) injury.



NOTES

These cover the many other possibilities, generally less obvious sources of danger, but which, under certain circumstances, may also cause damage or injury.

2



WARNINGS

- Model engine fuel is poisonous. Do not allow it to come into contact with the eyes or mouth. Always store it in a clearly marked container and out of the reach of children.



- Model engine fuel is also highly flammable. Keep it away from an open flame, excessive heat, sources of sparks, or anything else which might ignite it. Do not smoke or allow anyone else to smoke, near to it.



- Never operate your engine in an enclosed space. Model engines, like automobile engines, exhaust deadly carbon-monoxide. Run your engine only in an open area.

- Model engines generate considerable heat. Do not touch any part of your engine until it has cooled. Contact with the muffler (silencer), cylinder head or exhaust header pipe, in particular, may result in a serious burn.



3



NOTES

- This engine is intended for model cars. Do not attempt to use it for any other purpose.
- Mount the engine in your model securely, following the manufacturers' recommendations, using appropriate screws and locknuts.
- Install an effective silencer (muffler). Frequent close exposure to a noisy exhaust (especially in the case of the more powerful highspeed engines) may eventually impair your hearing and such noise is also likely to cause annoyance to others over a wide area.
- The wearing of safety glasses is also strongly recommended.
- Take care that the glowplug clip or battery leads do not come into contact with rotating parts. Also check that the linkage to the throttle arm is secure.
- For their safety, keep all onlookers (especially small children) well back (at least 20 feet or 6 meters) when preparing your model for running.



NOTES

- Before starting the engine, always check the tightness of all the screws and nuts especially those of joint and movable parts such as throttle arm. Missing retightening the loose screws and nuts often causes the parts breakage that is capable of harming you.
- To stop the engine, fully retard the throttle stick and trim lever on the trans-mitter, or, in an emergency, cut off the fuel supply by pinching the fuel delivery line from the tank.
- Warning! Immediately after a glowplug-ignition engine has been run and is still warm, conditions sometimes exist whereby it is just possible for the engine to abruptly restart if it is rotated over compression WITHOUT the glowplug battery being reconnected.

NOTES WHEN APPLYING AN ELECTRIC STARTER

Do not over-prime. This could cause hydraulic lock and damage the engine on application of the electric starter.

If over-primed, remove glowplug, close needle-valve and apply starter to pump out surplus fuel. Cover the head with a rag to prevent pumped out fuel coming into your eyes.

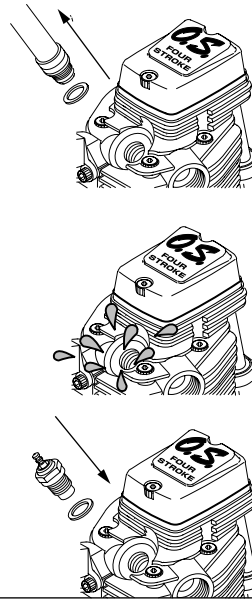

6







INTRODUCTION

The FS-26S-C Ver.II is an overhead valve four stroke cycle engine designed expressly for 1/10 class R/C vehicles. Newly designed 20P carburetor has a bigger bore of 5mm for increased power. For longer life of the engine, Super Air Cleaner 102S is supplied as standard.

Note:

As delivered, the carburetor is not installed on the engine.

STANDARD ACCESSORIES

- Glow Plug Type F (included with the engine) 
- Super Air Cleaner 102S Assembly 
- Hyper Exhaust Gasket 
- Insulator 
- Carburetor Retainer 
- Intake Pipe Assembly 
- Carburetor Complete (Type 20P) 

7

BEFORE STARTING

Tools, accessories, etc. The following items are necessary for operating the engine.

FUEL

Generally, it is suggested that the user selects a fuel that is commercially available for model two-stroke engines and contains 10-30% nitromethane. As a starting point, we recommend a fuel containing 20% nitromethane, changing to a fuel containing more nitro if necessary. When the brand of fuel is changed, or the nitro content increased, it is advisable to repeat the running-in procedure referred to in the RUNNING-IN paragraphs. Please note that with high-nitro fuels, although power may be increased for competition purposes, glowplug elements do not last as long and engine life will be shortened.

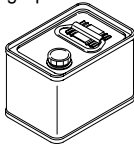

REMINDER!



Model engine fuel is poisonous. Do not allow it to come into contact with the eyes or mouth. Always store it in a clearly marked container and out of the reach of children.



Model engine fuel is also highly flammable. Keep it away from open flame, excessive heat, sources of sparks, or anything else which might ignite it. Do not smoke or allow anyone else to smoke, near to it.

FUEL FILTER

To installed in the fuel line between fuel tank and carburetor to prevent dust coming into the carburetor.

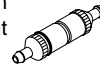

GLOWPLUG IGNITER

Commercially available handy glowplug heater in which the glowplug battery and battery leads are integrated.

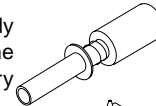

STARTER BOX

For starting the engine.

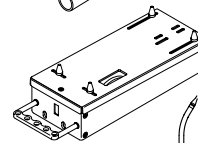

FUEL PUMP

For filling the fuel tank, a simple, polyethylene "squeeze" bottle, with a suitable spout, is required.



8

SILICONE FUEL LINE

Heatproof silicone tubing of approx. 5mm o.d. and 2mm i.d. is required for the connection between the fuel tank and engine.

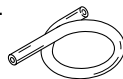

TOOLS

HEX WRENCH

Necessary for engine installation.
1.5mm, 2mm, 2.5mm, 3mm



SCREWDRIVER

Necessary for carburetor adjustments.
No.1, No.2, etc



LONG SOCKET WRENCH WITH PLUG GRIP

Recommended for easy removal and replacement of the angled and recessed glowplug, the O.S. Long Socket Wrench incorporates a special grip.

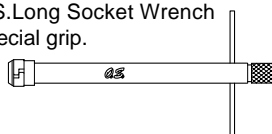

BASIC ENGINE PARTS

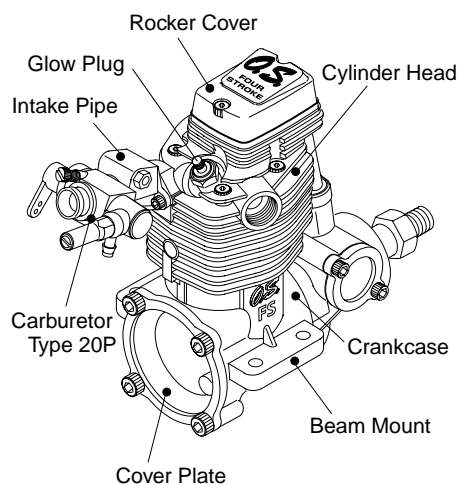

9

GLOWPLUG

The FS-26S-C Ver.II is supplied with an O.S. Type F glowplug, specially designed for O.S. four-stroke engines.

The role of the glowplug

With a glowplug engine, ignition is initiated by the application of a 1.5-volt power source. When the battery is disconnected, the heat retained within the combustion chamber remains sufficient to keep the plug filament glowing, thereby continuing to keep the engine running. Ignition timing is 'automatic' : under reduced load, allowing higher rpm, the plug becomes hotter and, appropriately, fires the fuel/air charge earlier; conversely, at reduced rpm, the plug becomes cooler and ignition is retarded.

Glowplug life

Particularly in the case of very high performance engines, glowplugs must be regarded as expendable. However, plug life can be extended and engine performance maintained by careful use, i.e.:

- Install a plug suitable for the engine.
- Use fuel containing a moderate percentage of nitromethane unless more is essential for racing events.
- Do not run the engine too lean and do not leave the battery connected while adjusting the needle.

When to replace the glowplug

Apart from when actually burned out, a plug may need to be replaced because it no longer delivers its best performance, such as when:

- Filament surface has roughened and turned white.
- Filament coil has become distorted.
- Foreign matter has adhered to filament or plug body has corroded.
- Engine tends to cut out when idling.
- Starting qualities deteriorate.

10

AIR CLEANER TYPE 102S

It has a single filter element and is intended primarily for circuit racing, where conditions are less damaging than the very dusty, loose surfaces of off-road operation for which the double-element Type 101 and 102 Air Cleaners are recommended.

The lower height of the Super Air-Cleaner 102S also facilitates easier installation in cars where available space may be restricted.

INSTALLATION OF AIR CLEANER

- Carefully clean the carburetor, removing any old adhesive or sealant that may have been previously used on the outside of the air intake.
- Press the air cleaner body firmly over the carburetor air intake. Make sure that the outer rim of the air intake engages the internal annular groove in the air cleaner: failure to do so may result in the air cleaner falling off.
- Position the air cleaner correctly, so that it does not interfere with the cylinder-head or obstruct the needle-valve.

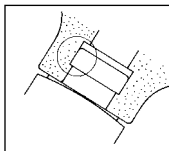

INSTALLING THE FILTER ELEMENT

- The element is already impregnated with a special filter oil. As this oil is very sticky, take care, when handling it, to prevent dust or dirt from adhering to the element. If your fingers become contaminated, wash them with soap and water.

- During storage, the oil may have become unevenly dispersed through the element. This will be indicated if the blue colour of the element material appears patchy. In this case, place the element in a small plastic bag and gently rub it between finger and thumb to redistribute the oil.

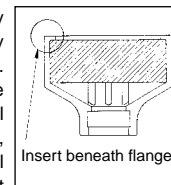

REPLACEMENT OF ELEMENT

- It is advisable to replace the filter element with a new one after not more than one hour of running time. Always remove contaminated elements carefully, to ensure that dirt cannot enter the carburetor.

11

INSTALLATION OF THE CARBURETOR & HYPER EXHAUST GASKET

- Install the insulator and intake manifold on the cylinder head.
- Install the carburetor retainer nut on the intake manifold temporarily.
- Install the carburetor gasket on the carburetor.
- Press the carburetor into the exhaust manifold and fasten the lock nut gradually until it stops.
- Fasten the lock nut a further 60-90 degrees. Do not fasten any further or the parts will be distorted and/or damaged.
- If you wish to change the fuel inlet position, loosen the needle holder and set the inlet at desired position, then fasten the needle holder gradually until it stops and fasten a further 45-60 degrees. Do not fasten any further or the inlet will be distorted, which results in fuel leaking.

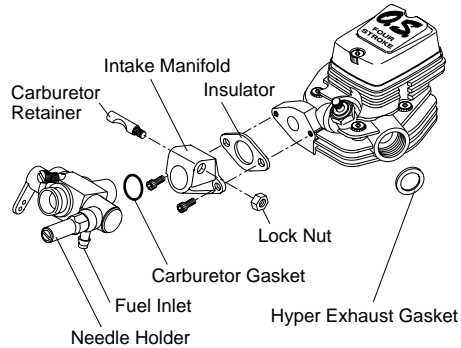

- Insert Hyper exhaust gasket into the exhaust port.

Note:
Installation procedure may vary according to the car kit.

12

ENGINE INSTALLATION

Make sure that the vehicle's engine mounting surfaces are level and in the same plane. Poor installation may cause distortion of the crankcase, bearings, etc., resulting in erratic running and loss of performance. The recommended screws for securing the engine are 3mm or 4-40 steel Allen hexagon socket type. If existing holes in the engine mount do not align perfectly with engine mounting lugs, enlarge them slightly with a needle-file so that screws enter vertically. Avoid forcing the screws. Secure with locknuts.

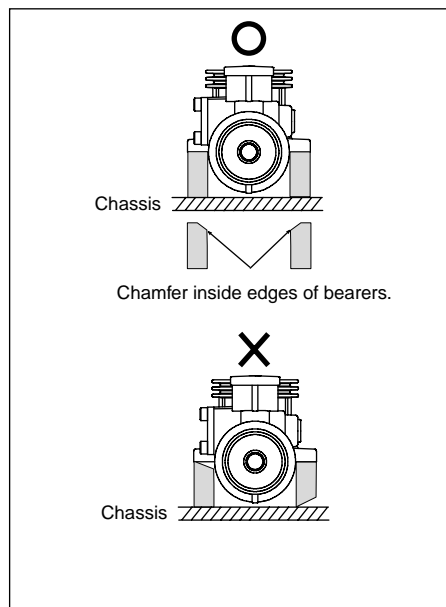

13

STARTING THE ENGINE & RUNNING-IN ('Breaking-in')

When starting the engine, lay the chassis on a stand so that tiers may not be in contact with the ground.

The somewhat violent changes of vehicle attitude that occur in off-road running, combined with the fact that, in buggy type cars, the fuel tank is often located some way from the carburetor, means that fuel 'head' at the carburetor can vary and upset running. Therefore, it is recommended that a muffler pressurized fuel feed system be used.

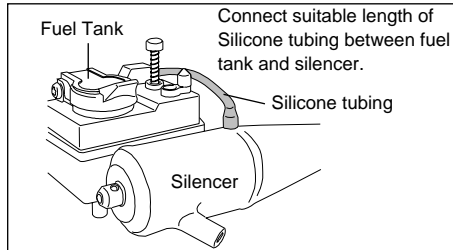

In the interests of a long working life and high performance, every internal-combustion engine need to be "run-in" (or "breaking-in" as the procedure is also known), while the engine is installed in the car and run the car.

- ◆ Fill the tank completely with fuel.

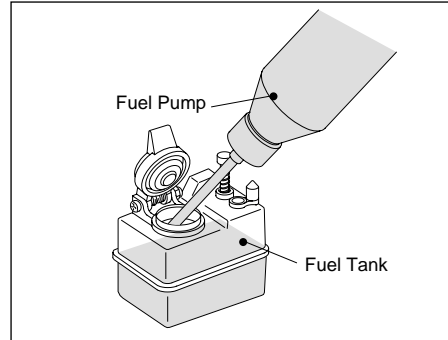

14

- ◆ Temporarily remove the glowplug to check that it glows bright red when energized.

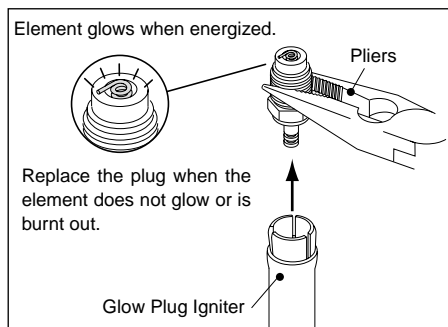

NOTE

- ⚠ When checking the glowplug while energizing it, do not hold it by fingers but use pliers. Do not come your face close to the glowplug or get burned with boiled fuel remaining in the coil.

- ◆ Turn the needle-valve clockwise slowly until it stops. This is the fully closed position. Do not force to turn further.

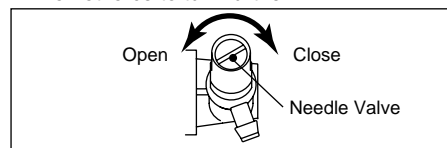

- ◆ Open the Needle-Valve 2 turns from the fully closed position.
- ◆ Set the throttle-stop screw so that the minimum throttle opening (idle setting) is approximately 2mm.

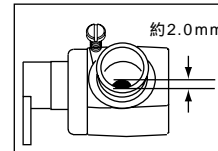

- Switch on the transmitter, followed by the receiver. Close the throttle stick and open the throttle trim lever to the idle setting.

15

- ◆ Prime the carburetor by pressing the fuel tank primer until fuel reaches the carburetor.

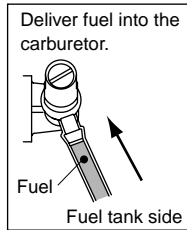

- ◆ Now connect glowplug battery lead to heat the plug filament and start the engine.

Attention:

It is vitally important to set the throttle at the correct position before starting the engine. If the engine is allowed to run with the throttle too far open under "no load" conditions (i.e. with the driving wheels not in contact with the ground) it will rapidly over-heat and may be seriously damaged.



- ◆ When the engine starts, first allow it to operate in short runs at the very rich starting settings, with the glowplug battery still connected and the driving wheels clear of the ground. The rich mixture will, under these conditions, provide adequate lubrication and cooling, indicated by profuse smoke from the exhaust.

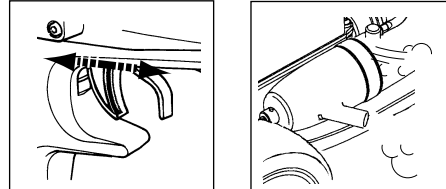

Next, disconnect the glowplug battery and try running the car on the track. If the engine stalls, open the throttle fractionally, but try to keep the engine running as rich as possible: if it stops because of being excessively over-rich, close the Needle-Valve 30° and try again.

16

- ◆ Run the car on the track until one tank of fuel has been consumed, then close the Needle-Valve 30° and run the car for another full tank of fuel. Repeat this procedure until 1/2 gallon of fuel have been consumed, during which time the throttle may be opened for brief bursts of increased power.

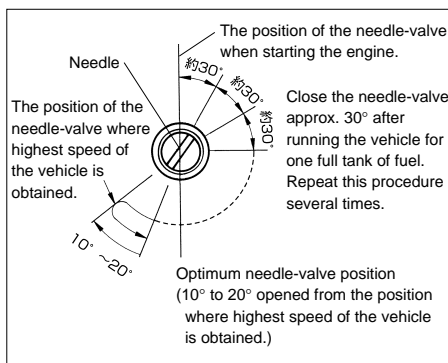

Now open the needle-valve 10°-20° from the setting at which the highest straight line speed is obtained. This slightly rich setting should provide the optimum balance. Run the car for about three more tanks of fuel to allow fine-tuning of any final adjustments.

Re-adjust the throttle stop screw, if necessary, so that the car may not move at idling.

Notes

Running-in the engine with excessive rich setting means nothing but damage the engine. Run-in the engine with adequate running temperature so that the heat can be conveyed to all the internal parts.

17

Note:

Adjusting the carburetor with no load condition means nothing but damage the engine. Do not run the engine with no load. In the event of any major working parts (e.g. piston/cylinder liner assembly) being replaced or the fuel changed, especially to high nitro fuel, or silencer and gear ratio and clutch timing changed, the complete running-in should be repeated.

- ◆ To stop the engine, close the throttle to idling speed, then shut it off completely with the trim lever on the transmitter. To cut off the fuel supply, pinch the fuel delivery tube to the carburetor.

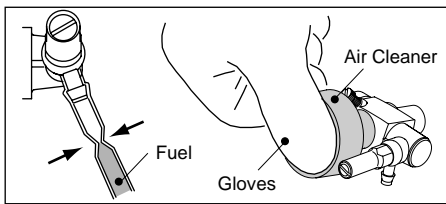

18

Warning!

Do not touch rotating parts, engine and silencer when stopping the engine as they become very hot, and contact with them may result in a serious burn.

VALVE ADJUSTING

Valve clearances are correctly set before any O.S. engine leaves the factory and, in normal use, will seldom require adjustment. However, if, after a considerable amount of running time, a loss of power is detected, or if the engine has been disassembled for repair, these clearances should be checked and reset as necessary.

For checking and adjusting the valve clearances, a VALVE ADJUSTING TOOL KIT is available as an optional accessory.

CARE & MAINTENANCE

- At the end of each operating session, drain the fuel tank, then energize the glowplug and try to re-start the engine to burn off any fuel that may remain inside. Repeat this procedure until the engine fails to fire. Then remove the glowplug and drain off any residue while the engine is still warm.
- Inject some corrosion-inhibiting after-run oil and rotate the crankshaft to distribute oil to the working parts. Do not inject such oil into the carburettor, however, as it may cause deterioration of the carburettor's O-ring seals.
- Apply a little lubricating oil to the rocker shaft and rocker arms.

Note!

These maintenance procedures will reduce the risks of corrosion or starting difficulties after a period of storage.

- When cleaning the exterior of the engine, use methanol or kerosene. Do not use gasoline or any solvent that might damage the silicone fuel tubing.

PARTS REPLACEMENT

- Over a long period, depending on how well your engine has been protected from the ingress of dust and grit and other causes of wear and tear, loss of performance may eventually occur in the form of reduced power, reluctant starting, unstable idling, etc. Having checked that this is not due merely to the need to readjust the valve clearances (for which an O.S. Valve Adjustment Kit - Code No. 72200060 - is available) inspection may then reveal that the replacement of some parts may be called for.

Contact the O.S. distributor in your country for parts or full service. See pages 25 & 26 of this booklet for details of parts.

19

TROUBLE SHOOTING

Symptom	
Engine fails to fire.	
Cause	Corrective action
Fuel tank is empty. Fuel not reaching the engine.	Fill the tank with fuel and repeat Priming procedure.
Glowplug element is burnt out. Glowplug battery discharged	Replace glowplug. Recharge or replace the battery.
Clogged fuel filter Air cleaner and silencer inside is dirty.	Clean or replace fuel filter. Replace cleaner element and clean inside silencer.
Over priming	Remove glowplug and pump excess fuel.
Fuel tubing is disconnected. Fuel tubing is kinked, split or has a hole.	Connect fuel tubing securely. Check the tubing carefully and replace if necessary.
Incorrect servo linkage	Re-linkage after setting servo at neutral.
Reverse rotating direction of starter box.	Make sure it rotates counter clockwise seen from crankshaft side.

20

Symptom	
Engine fires intermittently but does not run.	
Cause	Corrective action
Insufficient fuel in the tank.	Fill the tank with fuel.
Deteriorated glowplug	Replace glowplug.
Clogged fuel filter Air cleaner and silencer inside is dirty.	Clean or replace fuel filter. Replace cleaner element and clean inside silencer.
Engine overheated	Wait until engine is cooled.
Incorrect clutch release	Adjust the tension of clutch spring.
Too immediately disconnecting plug battery.	Do not disconnect plug battery and wait until r.p.m. become stable.
Fuel in the tank extremely bubbled	Fit O rings to the tank screws to prevent bubbles.

21

Symptom	
Unstable idle	
Cause	Corrective action
Unsuitable glowplug	Use suggested glowplug in the instructions.
Unsuitable fuel	Do not use extremely high nitro or low oil fuel.
Silencer is disconnected or has play	Install silencer securely.

Symptom	
Not reaching expected peak r.p.m.	
Cause	Corrective action
Insufficient warming up or running-in.	Set the needle only after warming up. Complete running-in.
Silencer or manifold is not securely connected or disconnected.	Check the connections and secure them.
Fuel tubing from tank to is split or broken.	Replace the tubing.

22

Symptom	
Poor response	
Cause	Corrective action
Deteriorated glowplug	Replace glowplug.
Incorrect carburetor settings	Readjust low r.p.m. range with needle Valve and Throttle Stop Screw.
Incorrect setting of transmitter Exponential function.	Check the transmitter setting.
Symptom	
Poor r.p.m. drop	
Cause	Corrective action
Too much throttle opening at idle.	Close Throttle Stop Screw to adequate position to lower idle r.p.m.
Incorrect carburetor fitting	Fit carburetor securely.

23

ENGINE EXPLODED VIEW

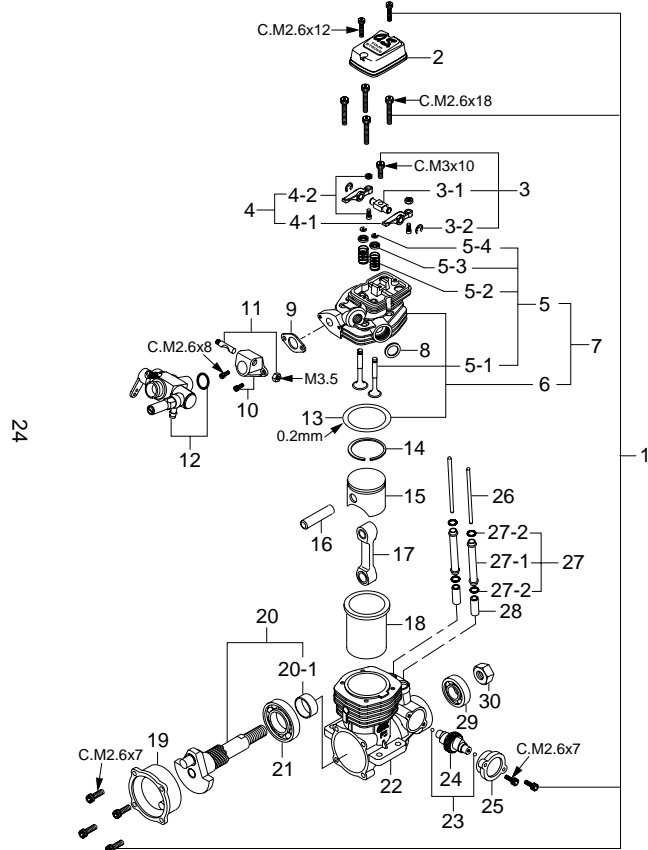

24

* Type of screw C...Cap Screw M...Oval Fillister-Head Screw
 F...Flat Head Screw N...Round Head Screw S...Set Screw

ENGINE PARTS LIST

No.	Code No.	Description
1	44113000	Screw Set
2	43004200	Rocker Cover
3	45761400	Rocker Support Assembly
3-1	45761410	Rocker Support
3-2	45761600	Rocker Arm Retainer (2pcs.)
4	45761000	Rocker Arm Assembly (1pair)
4-1	45761100	Rocker Arm (1pc.)
4-2	45761200	Tappet Adjusting Screw
5	45760020	Valve Assembly (1pair)
5-1	45760110	Valve (1pc.)
5-2	45760210	Valve Spring (1pc.)
5-3	45060309	Valve Spring Seat (1pc.)
5-4	46160400	Valve Spring Retainer (2pcs.)
6	44104100	Cylinder Head (W/Gasket)
7	44104020	Cylinder Head Assembly (W/Gasket and Valve Assembly)
8	45169100	Hyper Exhaust Gasket (2pcs.)
9	21381950	Insulator
10	45269400	Intake Pipe Assembly
11	21481700	Carburetor Retainer
12	45282000	Carburetor Complete (Type 20P)
13	22714100	Cylinder Head Gasket
14	44103400	Piston Ring
15	44103200	Piston
16	22706000	Piston Pin
17	45705000	Connecting Rod
18	44103100	Cylinder Liner
19	45707010	Cover Plate
20	44102010	Crankshaft
20-1	45702100	Crankshaft Spacer
21	22830000	Crankshaft Ball Bearing (Rear)
22	44101010	Crankcase
23	45762100	Thrust Ball (2pcs.)
24	45762010	Camshaft
25	45701110	Cam Cover
26	44166000	Push Rod (2pcs.)
27	44166100	Push Rod Cover Assembly (2pcs.)
27-1	44166110	Push Rod Cover (1pc.)
27-2	24881824	Push Rod Cover "O" Ring (2pcs.)
28	45264000	Cam Follower (2pcs.)
29	45231000	Crankshaft Ball Bearing (Front)
30	23210007	Propeller Nut
	71615009	Glow Plug Type F
	72403202	Super Air Cleaner 102S (W/3 filter elements)
	72403212	102S Cleaner Body
	72403120	101,102 Filter Element (6pcs.)

25

The specifications are subject to alteration for improvement without notice.

CARBURETOR EXPLODED VIEW & PARTS LIST

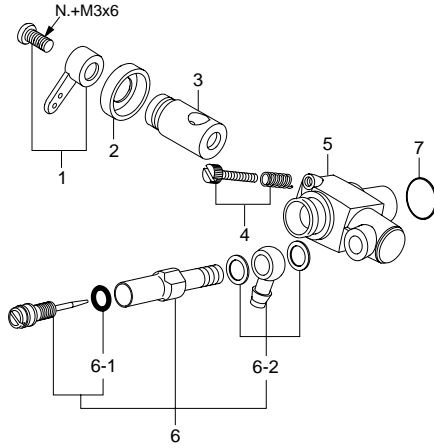

No.	Code No.	Description
1	22081408	Throttle Lever Assembly
2	21283210	Carburetor Dust Cover
3	45282200	Carburetor Rotor
4	22681310	Throttle Stop Screw
5	45282100	Carburetor Body
6	21285901	Needle-valve Assembly
6-1	27881820	"O" Ring (2pcs.)
6-2	21881950	Universal Nipple No.14 Assembly
7	22615000	Carburetor Rubber Gasket

The specifications are subject to alteration for improvement without notice.

* Type of screw

C...Cap Screw M...Oval Fillister-Head Screw
F...Flat Head Screw N...Round Head Screw S...Set Screw

26

O.S. SPEED
RACING ENGINE PARTS

O.S. GENUINE PARTS & ACCESSORIES

■ GLOWPLUG ■ HYPER EXHAUST SET

Type F
(71615009)



• For Kyosho Super 10
(44126000)

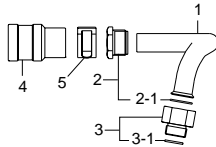

1 (44126100)	Hyper Exhaust Pipe
2 (45169200)	Exhaust Pipe Lock Nut
2-1 (45169210)	Exhaust Gasket (2pcs.)
3 (44126200)	Exhaust Adaptor
3-1 (45169100)	Hyper Exhaust Gasket (2pcs.)
4 (44126300)	Pipe Joint
5 (44126400)	Clamp

• For Kyosho Spider
(44126010)

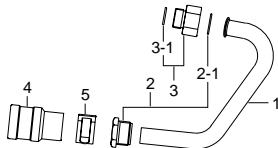

1 (44126110)	Hyper Exhaust Pipe
2 (45169200)	Exhaust Pipe Lock Nut
2-1 (45169210)	Exhaust Gasket (2pcs.)
3 (44126200)	Exhaust Adaptor
3-1 (45169100)	Hyper Exhaust Gasket (2pcs.)
4 (44126300)	Pipe Joint
5 (44126400)	Clamp

27

■ SUPER JOINT TUBE 15
(72103310)



■ F-2000 4C CAR SILENCER
(44125100)



■ FS-26S-C ENGINE MOUNT
• For Kyosho V-oneR, S
(72404400)

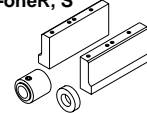

• For HPI Nitro Series
(72404500)



■ VALVE ADJUSTING
KIT
(72200060)



■ LONG SOCKET WRENCH
WITH PLUG GRIP
(71521000)

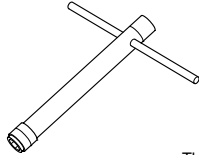

■ CAP SCREW SET (10pcs. / set)

- M2.6x7 (79871020)
- M2.6x8 (79871025)
- M2.6x12 (79871040)
- M2.6x18 (79871055)

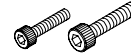

The specifications are subject to alteration for improvement without notice.

THREE VIEW DRAWING

SPECIFICATIONS

■ Displacement	4.41cc (0.270cu.in.)
■ Bore	18.5mm (0.728in.)
■ Stroke	16.4mm (0.646in.)
■ Practical R.P.M.	2,000-22,000 r.p.m.
■ Power output	0.5ps / 17,000 r.p.m.
■ Weight	242.5g (8.56oz.)

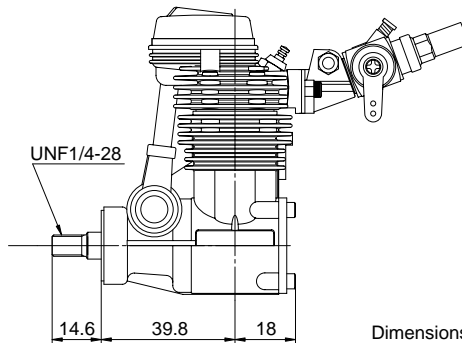
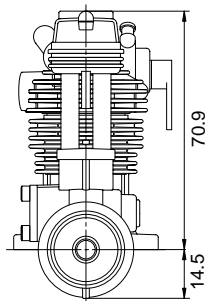
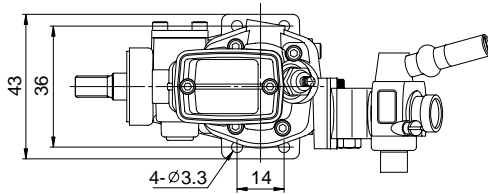

Dimensions (mm)

MEMO

.....

.....

.....

.....

.....

.....

.....

.....

.....

.....

.....



O.S. ENGINES MFG. CO., LTD.

6-15 3-Chome Imagawa Higashisumiyoshi-ku

Osaka 546-0003, Japan TEL. (06) 6702-0225

FAX. (06) 6704-2722

URL : <http://www.os-engines.co.jp>