

MAX-50SX-HRING HYPER

INSTRUCTION MANUAL

It is of vital importance, before attempting to operate your engine, to read the general '**SAFETY INSTRUCTIONS AND WARNINGS**' section on pages 2-5 of this booklet and to strictly adhere to the advice contained therein.

- Also, please study the entire contents of this instruction manual, so as to familiarize yourself with the controls and other features of the engine.
- Keep these instructions in a safe place so that you may readily refer to them whenever necessary.
- It is suggested that any instructions supplied with the model, radio control equipment, etc., are accessible for checking at the same time.

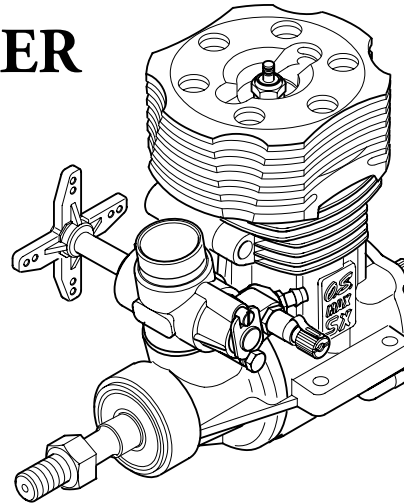

CONTENTS

SAFETY INSTRUCTIONS AND WARNINGS ABOUT YOUR O.S. ENGINE -----	2-5	STARTING, RUNNING-IN ("Breakingin") -----	21-25
NOTES ON INSTALLING COOLING-FAN AND CLUTCH -----	6-7	ADJUSTMENT -----	26-30
NOTES WHEN APPLYING AN ELECTRIC STARTER, INSTALLATION OF THROTTLE SERVO -----	8-9	ADJUSTMENT CHART -----	31
NOTES ON HEATING THE GLOW PLUG INTRODUCTION, ENGINE PARTS NAME -----	10-12	CARE AND MAINTENANCE -----	32-33
BEFORE STARTING, INSTALLATION OF THE ENGINE -----	13-16	TROUBLE SHOOTING -----	34-37
INSTALLATION OF THE GLOW PLUG & CARBURETOR -----	17	ENGINE EXPLODED VIEW & PARTS LIST -----	38-39
GLOWPLUGS -----	18	CARBURETOR EXPLODED VIEW & PARTS LIST -----	40-41
CARBURETOR CONTROLS -----	19-20	O.S. GENUINE PARTS & ACCESSORIES -----	42
		THREE VIEW DRAWING -----	43
		MEMO -----	44

SAFETY INSTRUCTIONS AND WARNINGS ABOUT YOUR O.S. ENGINE

Remember that your engine is not a "toy", but a highly efficient internal-combustion machine whose power is capable of harming you, or others, if it is misused.





As owner, you, alone, are responsible for the safe operation of your engine, so act with discretion and care at all times.

If at some future date, your O.S. engine is acquired by another person, we would respectfully request that these instructions are also passed on to its new owner.

■ The advice which follows is grouped under two headings according to the degree of damage or danger which might arise through misuse or neglect.

 WARNINGS
<p>These cover events which might involve serious (in extreme circumstances, even fatal) injury.</p>

 NOTES
<p>These cover the many other possibilities, generally less obvious sources of danger, but which, under certain circumstances, may also cause damage or injury.</p>

 WARNINGS	
<ul style="list-style-type: none"> • Never touch, or allow any object to come into contact with, the rotating parts.  • Model engine fuel is poisonous. Do not allow it to come into contact with the eyes or mouth. Always store it in a clearly marked container and out of the reach of children.  • Model engine fuel is also highly flammable. Keep it away from open flame, excessive heat, sources of sparks, or anything else which might ignite it. Do not smoke or allow anyone else to smoke, near to it.  	<ul style="list-style-type: none"> • Never operate your engine in an enclosed space. Model engines, like automobile engines, exhaust deadly carbon-monoxide. Run your engine only in an open area. • Model engines generate considerable heat. Do not touch any part of your engine until it has cooled. Contact with the muffler (silencer), cylinder head or exhaust header pipe, in particular, may result in a serious burn. 



NOTES

- This engine was designed for model helicopters. Do not attempt to use it for any other purpose.
- Mount the engine in your model securely, following the manufacturers' recommendations, using appropriate screws and locknuts.
- Install an effective silencer (muffler). Frequent close exposure to a noisy exhaust (especially in the case of the more powerful high-speed engines) may eventually impair your hearing and such noise is also likely to cause annoyance to others over a wide area.
- Check the linkage to the throttle arm before each flight.
- Avoid sudden high r.p.m. immediately after the engine is started, as the clutch will engage and you may be struck by the rotor.
- After starting the engine, carry out any needle-valve readjustments after stopping the rotor by closing the throttle to the lowest r.p.m.. Stop the engine before attempting to make other adjustments to the carburetor.
- Use an electric starter. The wearing of safety glasses is also strongly recommended. Press the rotor head down securely.
- Take care that the glow plug clip or battery leads do not come into contact with rotating parts.
- Adjust the throttle linkage so that the engine stops when the throttle stick and trim lever on the transmitter are fully retarded. Alternatively, the engine may be stopped by cutting off the fuel supply. Never try to stop the engine physically.



NOTES

- Take care that loose clothing (ties, shirt sleeves, scarves etc.) do not come into contact with the rotor. Do not carry loose objects (such as pencils, screwdrivers, etc.) in a shirt pocket from where they could fall through the rotor disc.
- For their safety, keep all onlookers (especially small children) well back (at least 20 feet or 6 metres) when preparing your model for flight. If you have to carry the model to the take-off point with the engine running, be especially cautious. Hold the rotor securely and keep well clear of spectators.
- Warning! Immediately after a glowplug-ignition engine has been run and is still warm, conditions sometimes exist whereby it is just possible for the engine to restart when turned over WITHOUT the glowplug battery being reconnected. Remember this if you wish to avoid the risk of accidents.

Notes on installing cooling fan and clutch

Do not use a tool which locks piston when installing a cooling-fan and clutch, or top of the piston may be damaged. Also, do not insert a screw driver or the similar into the exhaust port.

It is recommended to use Crankshaft Clamp 3246 (Code No.71530400) available as an optional tool.

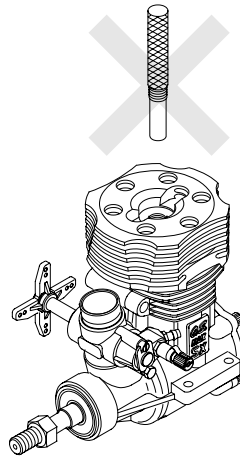

Notes on installing cooling fan and clutch

Do not grip the engine mounting beams with a vise, or the crankcase will be distorted which will result in engine breaking.

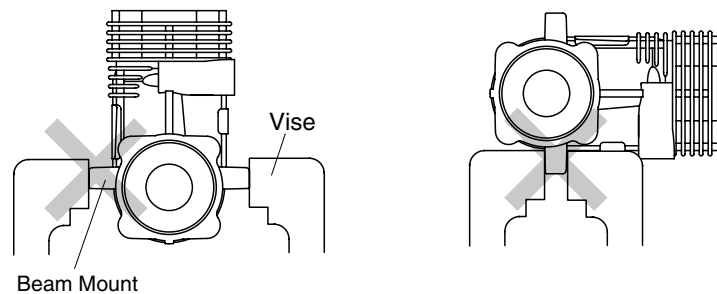

NOTES WHEN APPLYING AN ELECTRIC STARTER

Because of this initial tightness, a standard electric starter may have difficulty in rotating the engine when cold, before it has been adequately run-in. In this case, use a high-torque type starter.

Do not over-prime. This could cause a hydraulic lock and damage the engine on application of the electric starter.

If over-primed, remove glowplug, close needle-valve and apply starter to pump out surplus fuel. Cover the head with a rag to prevent pumped out fuel from getting into your eyes.

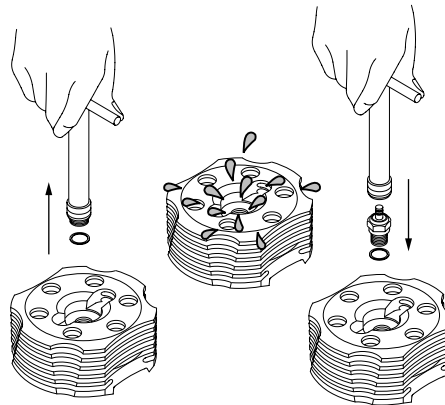

Linking the throttle servo to the carburetor

Link the throttle servo to the carburetor using the throttle lever supplied.

Throttle control rod A and B should be equal length. Set the linkage so that the servo output lever and throttle lever are parallel when the throttle stick on the transmitter is at middle position. Installing hole intervals on the F lever and on the J lever are different. Decide the lever to use according to the servo used. Be sure to cut off another lever to avoid any interference.

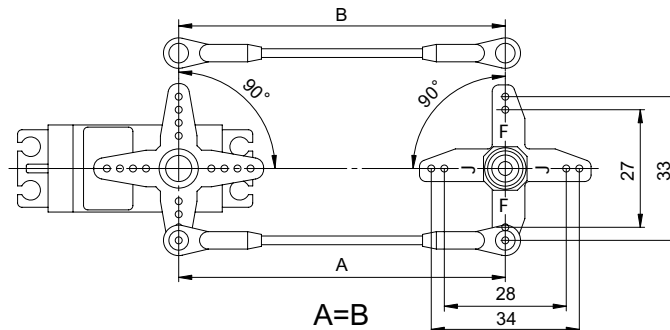

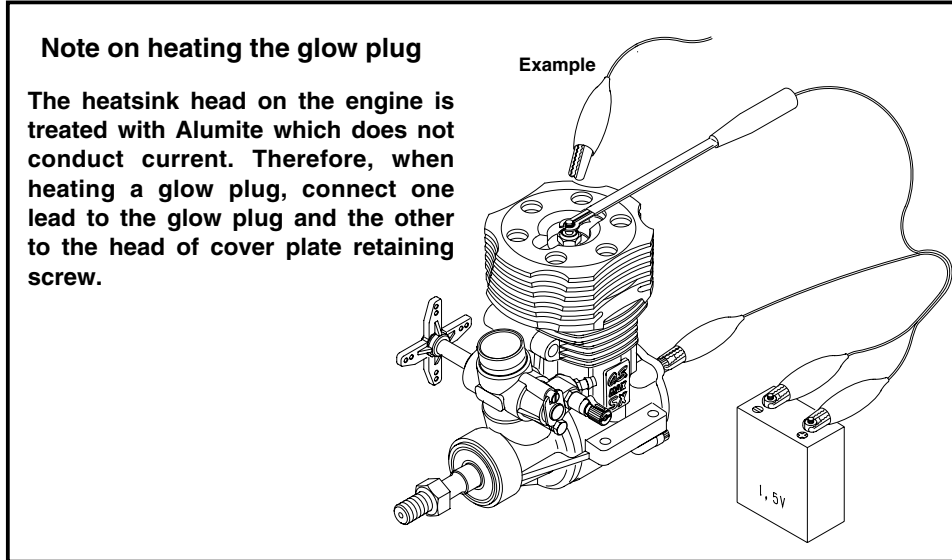

INTRODUCTION

This is the increased power version of the 50SX-H RING which is developed expressly for F3C M class helicopter competition utilizing 0.50 cubic inch engines.

Blue Alumite heatsink head increases cooling capacity. Newly designed combustion chamber shape offers stable output both at hovering and high speed. The 60LH carburetor has a big 10mm bore which contributes the power increase. The cover plate has a cell to accept a sensor designed to install in the cover plate from the Futaba GY-701 Governor.

STANDARD ACCESSORIES

- Glow Plug No.8
- 60LH Carburetor Assembly
 - Carburetor Rubber Gasket
 - Carburetor Sealing Washer

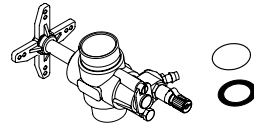

- Instruction manual

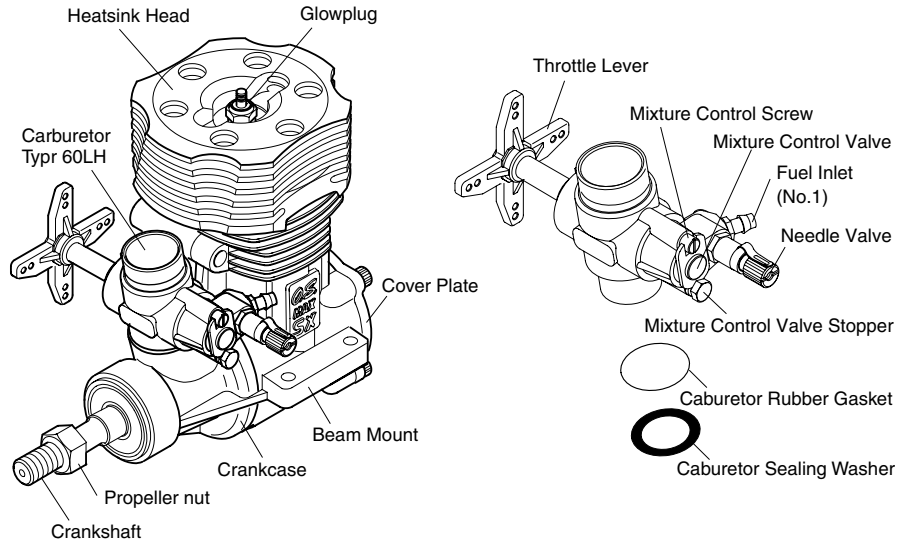

Tools, accessories, etc. The following items are necessary for operating the engine.

Items necessary for starting

Glow Plug

O.S. No.8 is supplied with the engine.



Battery leads

These are used to conduct current from the battery to the glowplug. Basically, two leads, with clips, are required, but, for greater convenience, twin leads with special glowplug connectors, as shown on the right, are commercially available.



Glowplug battery

The power source for heating the glowplug may be either a large heavy-duty 1.5volt dry cell, Ni-cd battery or glowplug Igniter.

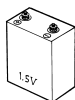

1.5 volt dry cell

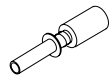

glowplug Igniter

In case of 1.5volt dry cell

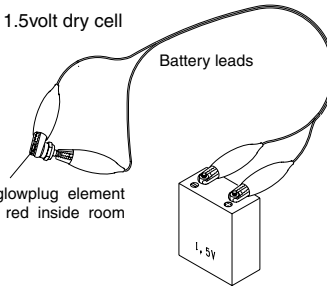

Make sure glowplug element glows bright red inside room or shadow.

Hexagon starting shaft

This shaft mounted on an electric starting motor is driven into the shaft cup to turn the engine.



Electric starter and starter battery

An electric starter is recommended for starting.

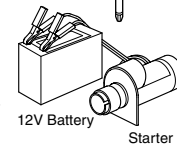

12V Battery

Starter

Fuel

Select, by practical tests, the most suitable fuel from among the best quality fuels available in your country for helicopter use. For the best throttle response, a fuel containing 10% to 30% nitromethane is preferable. Lubricants may be either castor-oil or a suitable synthetic oil (or a blend of both) provided that they are always of top quality. For consistent performance and long engine life, it is essential to use fuel containing AT LEAST 18% lubricant by volume. Some fuels containing coloring additives tend to deteriorate and may adversely affect running qualities. If in doubt compare to a fuel known to be good.

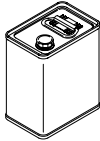

Reminder!

Model engine fuel is poisonous. Do not allow it to come into contact with the eyes or mouth. Always store it in a clearly marked container and out of the reach of children.



Model engine fuel is also highly flammable. Keep it away from open flame, excessive heat, sources of sparks, or anything else which might ignite it. Do not smoke, or allow anyone else to smoke, near to it.



Fuel Pump

Alternatively, one of the purpose-made manual or electric fuel pumps may be used to transfer fuel directly from your fuel container to the fuel tank.

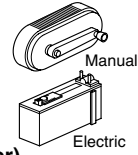

O.S. Super Filter (Fuel Can Filter)

Install a filter to the outlet tube of your refueling container to prevent entry of foreign matter into fuel tank. O.S. 'Super Filters' (large and small) are available as optional extras.



Fuel Filter

It is recommended to install a good in-line filter between the fuel tank and carburetor to prevent entry of foreign matter from getting into the carburetor.

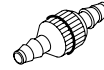

Silicone Fuel Line

Heatproof silicone tubing of approx. 5mm o.d. and 2.5mm i.d. is required for the connection between the fuel tank and engine.

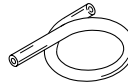

TOOLS

Hex Drivers

Necessary for engine installation.
1.5mm, 2mm, 2.5mm, 3mm



Phillips Screwdriver

No.1, No.2, etc.

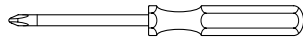

Screwdriver

Necessary for carburetor adjustments.
No.1, No.2, etc



Socket Drivers

5mm, 5.5mm, 7mm

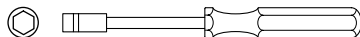

Long Socket Wrench With Plug Grip

Recommended for easy removal and replacement of the angled and recessed glowplug, the O.S. Long Socket Wrench incorporates a special grip.



End Wrenches

8mm, 13mm, 14mm, etc.

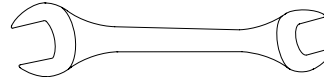

Needle Nose Pliers

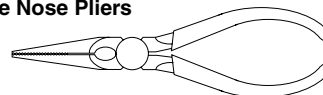

INSTALLATION OF THE ENGINE

The under-surfaces of all O.S. engine beam mounting lugs are precision machined flat and exactly parallel to the engine's horizontal axis. It is essential that the engine mounts in the model are also accurately made and aligned. If they are not, they will cause stress and distortion within the engine itself, probably resulting in loss of performance and internal damage.

The recommended screws for securing the engine to the engine mounts in the model are 3mm or 4-40 steel Allen type. It is also advisable to use lock washers or LOCTITE to prevent nuts from loosening.

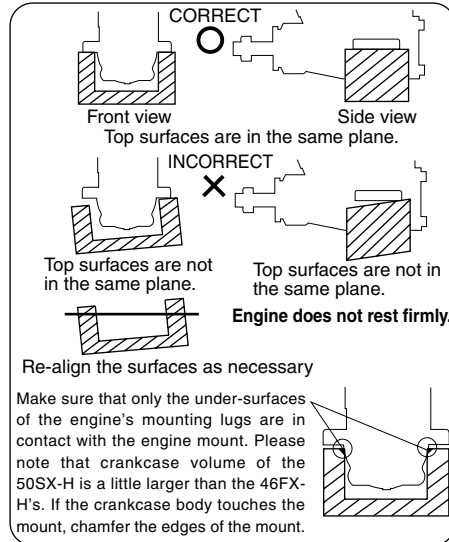

GLOWPLUG/CARBURETOR

■ INSTALLING THE GLOWPLUG

Install washer on glowplug and insert carefully into Heatsink-head, making sure that it is not cross-threaded before tightening firmly.

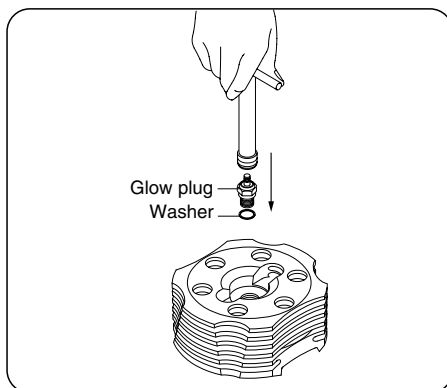

■ INSTALLATION OF THE CARBURETOR

1. Loosen the retainer screw, rotate the carburetor to its correct position and press it well down into the intake boss, compressing the rubber gasket as shown in the sketch, before re-tightening screw.
2. Rotate the retainer screw gently until it stops, then tighten a further 90-120 degrees. Do not over-tighten the screw as this will damage the carburetor body.

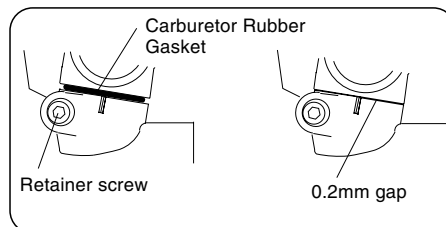



Since the glowplug and fuel combination used may have a marked effect on performance and reliability, it would be worthwhile to experiment with different plug types. Recommended O.S. plugs are No.8, No.7 and No.10 (Former A5) .

Carefully install plug finger-tight, before final tightening with the correct size plug wrench.

The role of the glowplug

With a glowplug engine, ignition is initiated by the application of a 1.5-volt power source. When the battery is disconnected, the heat retained within the combustion chamber remains sufficient to keep the plug filament glowing, thereby continuing to keep the engine running. Ignition timing is 'automatic' : under reduced load, allowing higher rpm, the plug becomes hotter and, appropriately, fires the fuel/air charge earlier; conversely, at reduced rpm, the plug become cooler and ignition is retarded.

GLOWPLUG

Glowplug life

Particularly in the case of very high performance engines, glowplugs must be regarded as expendable items. However, plug life can be extended and engine performance maintained by careful use, i.e.:

- Install a plug suitable for the engine.
- Use fuel containing a moderate percentage of nitromethane unless more is essential for racing events.
- Do not run the engine too lean and do not leave the battery connected while adjusting the needle.

When to replace the glowplug

Apart from when actually burned out, a plug may need to be replaced because it no longer delivers its best performance, such as when:

- Filament surface has roughened and turned white.
- Filament coil has become distorted.
- Foreign matter has adhered to filament or plug body has corroded.
- Engine tends to cut out when idling.
- Starting qualities deteriorate.

With a fixed-wing model, power failure is rarely a serious threat to the safety of the aircraft since it can usually glide down to a safe landing. In a helicopter, on the other hand, it is vitally important that the engine keeps running and that there is a quick and reliable response to the throttle in order to ensure safe ascent and descent of the model.

Two adjustable controls are provided on this carburetor.

● **The Needle Valve:**

When set to produce maximum power at full throttle, this establishes the basic fuel/air mixture strength. This is then maintained by the carburetor's automatic mixture control system to cover the engine's requirements at reduced throttle settings.

● **The Mixture Control Screw (Mixture Control Valve):**

For adjusting the mixture strength at part-throttle and idling speeds, to obtain steady idling and smooth acceleration to medium speeds. The Mixture Control Valve has been factory set for the approximate best result. First, run the engine as received, and re-adjust the Mixture Control Valve only when necessary.

CARBURETOR CONTROLS

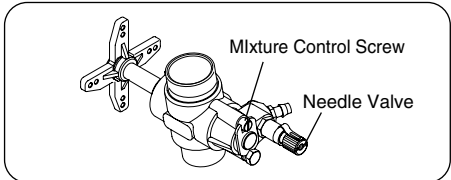

NOTE
As the idle mixture control screw is installed with LOCTITE, it may initially feel stiff, and it is suggested to use a littli larger screwdriver. The screw can be turned only 90 degrees either way. Do not force to turn further, or it may break or cause trouble.

■ **BASIC POSITION OF MIXTURE CONTROL SCREW**
(Mixture Control Valve)

As delivered, the Mixture Control Screw is positioned at approximately the center as shown in the sketch. Mixture gets lean when the Mixture Control Screw is turned right, while mixture gets rich when the Mixture Control Screw is turned left. With a model helicopter, adjustments vary with combined various factors such as climatic conditions, fuel, muffler, main rotor, weight of the model, gear ratio, etc. Therefore the Mixture Control Screw position varies with each model and set-up, and it is normal if the Mixture Control Screw position is off the center.

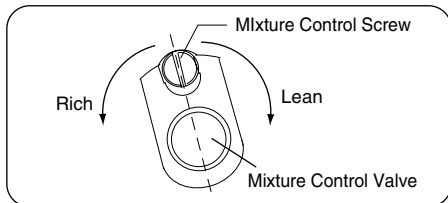

■ **GRADUATIONS ON THE CARBURETOR BODY**

As shown in the sketch, the carburetor has graduation marks.

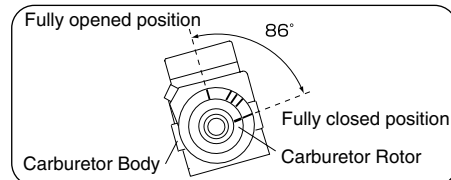

When the triangle mark on the carburetor rotor meets the most right mark, throttle is fully closed. When the triangle mark meets the top mark, throttle is fully open. The range is 86 degrees. You may use other three marks as the reference marking of throttle opening to your preference when hovering.

WARNING!

Never try to check the triangle mark position while the engine is running and rotor is rotating, or you may be hit by rotating rotor which results in serious injury. Stop the engine and rotor before checking the triangle mark position.

STARTING

Be sure to use an electric starter to start the engine.

⚠ **Never fail to check the tightness of screws and nuts, especially engine mounting and moving parts (e.g. throttle lever).**

Be sure to use a muffler pressurized fuel feed. Use the same fuel as you intend to employ for actual operation of your model.

Starting procedure is as follows:

1. Fill the fuel tank with fuel. When filled, prevent the fuel from flowing into the carburetor with a commercially available fuel stopper, etc. Release the stopper before starting the engine.
2. Make sure that plug element glows red, and install the plug in the cylinder head.

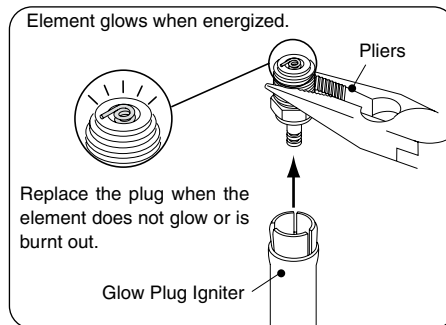

WARNING

When checking the plug element hold the plug with tools, such as pliers, etc. Do not hold near your face or the fuel remaining in the filament may burn you.

1. Opening and closing of the Needle-Valve

Turn the needle clockwise to close the needle-valve, and turn the needle counter-clockwise to open the needle-valve as shown in the sketch.

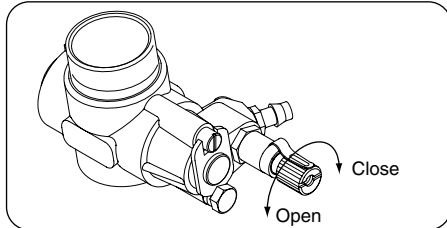

2. Opening the needle-valve

Firstly, turn the needle clockwise slowly until it stops. The position it stops is the fully closed position of the needle-valve. Make note this position for reference..
Open the needle-valve 1.5 turns.

3. Preparation of the starter

Install the starting shaft to the starter securely.
Poor installation will allow the shaft to swing which can be dangerous.

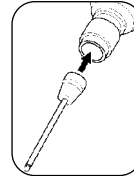

4. Checking the rotating direction of the starter

Make sure that the starter rotates in the direction shown in the sketch. If the direction is reverse, reverse the leads on battery.

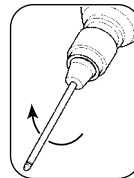

5. Inserting the starter shaft

Insert the starting shaft into the shaft cup securely.

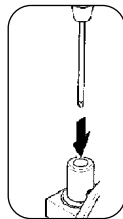

6. Priming

Without heating the glowplug, open the throttle a little from the idle position. Turn the engine using the starter until the fuel is seen to reach the carburetor.

7. Preparation of starting

Make sure that the transmitter throttle stick is at the fully closed position and the throttle trim at center position, and make sure that idle-up switch on the transmitter is off.

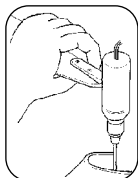

Hold the rotor head by hand so that rotor cannot rotate when the engine is Started. Also, steady the model with a foot on the landing gear skid.

8. Starting

Connect the battery to the glowplug and start the engine by applying the starter. When started, switch off the starter and withdraw the starting shaft after making sure the rotation of the starter shaft stops.

9. Stopping the engine

Fully pull down the throttle trim on the transmitter.

In case the engine does not stop.

Hold the rotor head, and pinch the fuel line to stop the fuel supply. If it still does not stop, pull off the fuel line from the carburetor.

It is necessary to readjust the throttle linkage so that the carburetor rotor is fully closed when the throttle stick and throttle trim on the transmitter are fully pulled Down.

NOTE:

If the throttle response is poor or the engine stops due to a temporarily over-rich mixture immediately after the engine is started, pinch the fuel line for one or two seconds until the engine r.p.m. increase and the engine runs steadily.

Reminder!



Never touch, or allow any object to come into contact with, the rotating rotor.

All internal-combustion engines benefit, to some degree, from extra care when they are run for the first few times known as running-in or breaking-in.

This allows the working parts to mate together under load at operating temperature.

However, because O.S. engines are made with the aid of the finest modern precision machinery and from the best and most suitable materials, only a very short and simple running-in procedure is required and can be carried out with the engine installed in the model.

For the first few flights with a new engine i.e. while the engine is being run-in set the needle-valve for a slightly rich mixture not excessively rich as this may result in poor throttle response and cause the engine to stop.

About 1.5 turn open from the normal setting will usually suffice.

The following adjustments are approximately correct when using a fuel containing 18-25% lubricant and 10-30% nitromethane.

Bear in mind that fuels containing relatively large percentages of power-boosting nitromethane operate at richer mixture settings than are needed for mild fuels and will, therefore, require the Needle Valve to be readjusted accordingly. The type and percentage of lubricant used is also a factor here, as noted later in these instructions.

This carburetor is not equipped with a throttle stop screw. Instead, idle speed is adjusted by means of the throttle trim lever on the transmitter.

Ⓐ This enables the full r.p.m. range, from idle to full power, to be controlled by the throttle stick, and then allows the engine to be stopped, from the transmitter, by closing the throttle completely with the trim lever.

Set up the throttle linkage as follows:

With the transmitter throttle trim lever fully retarded, adjust the throttle servo linkage so that the throttle rotor is (a) fully open when the transmitter throttle stick is fully advanced and (b) fully closed (i.e. engine stopped) when the stick is fully retarded. The idle speed is then set by advancing the throttle trim lever to the point where the engine runs, steadily and reliably, at the desired idle speed.

- Ⓑ As a safety measure, first check the transmitter controls, including the throttle stick and trim lever positions, and hold the main rotor securely before starting the engine.
- Ⓒ Warm the engine by allowing it to idle for about 30 seconds. If the engine stops, advance the throttle trim lever slightly to increase the idle rpm. Then open the throttle sufficiently to 'float' the model above the ground.

Ⓓ If, at this time, the engine is slow to pick up and produces an excess of exhaust smoke, the mixture is too rich. Correct this condition by turning the Mixture Control Screw clockwise. If the mixture is extremely rich, engine rpm will become unstable: opening the throttle will produce a great deal of smoke and rpm may drop suddenly or the engine may stop. This condition may also be initiated by an excessively prolonged warming-up period.

Ⓔ If, on the other hand, the mixture is too lean, this will be indicated by a marked lack of exhaust smoke and a tendency for the engine to cut out when the throttle is opened. In this case, turn the Mixture Control Screw counter-clockwise to enrich the mixture.

Ⓕ Turn the Mixture Control Screw 5 degrees at a time.

Ⓖ Having provisionally set the idle mixture, the next step is to adjust the mixture for hovering flight.

Ⓗ Hover the model and actuate the throttle to observe response over the medium speed range. If the engine smokes excessively and throttle response is poor, the mixture is too rich; in which case, land the model and turn the Needle Valve clockwise. Do not close the Needle Valve too much, keeping it a little on the rich side at this stage.

Ⓙ If, on the other hand, hovering is not stable and response to the throttle is over-sensitive, or if the engine tends to overheat, this indicates that the mixture is too lean and should be corrected by turning the Needle Valve counter-clockwise.

Ⓚ When satisfactory hovering flight has been achieved, land the model again and re-check the engine's idle qualities.

- Ⓚ After about 10 seconds of idling, open the throttle to 'float' the model. If the transition is smooth, the idle mixture is O.K. If the symptoms of either rich or lean running are observed, readjust the Mixture Control Screw accordingly.
- Ⓛ Now adjust the Needle Valve to achieve the best performance when the model is flying at full throttle. If, at full throttle, acceleration is poor, the exhaust unduly smoky and the model fails to reach expected straight line speed, the mixture is too rich and the Needle Valve setting will need to be reduced. If, however, after smoothly accelerating to satisfactory high-speed straight and level flight, power is lost when the model is pulled up into a climb, the mixture is too lean. In this case, land the model immediately and readjust Needle Valve to a richer setting.
- Ⓜ Now re-check hovering performance and, if necessary, fine-tune the mixture for hovering flight.
- Ⓝ For helicopters, good throttle response at medium r.p.m. (e.g. hovering speeds) is most important, since this is a power range widely used in helicopter flight. The optimum fuel/air mixture strength at medium speeds is dependent on obtaining balanced adjustment of both the Needle Valve and the Mixture Control.
- If both controls are already at their optimum setting, some modification to these settings may be necessary to achieve satisfactory mid-range throttle response, but such readjustments should only be made within the range where idle reliability and high-speed performance are not unduly compromised. Readjustments should therefore be carried out as follows:

- Ⓞ If the mid-range throttle response is not rapid and positive (indicating a rich mid-range mixture), turn the Needle Valve 2 or 3 clicks clockwise, or turn the Mixture Control Screw 1-3 degrees clockwise.
- Ⓟ If, on the other hand, the response to mid-range throttle movement is too sensitive (indicating a lean mid-range mixture), turn the Needle Valve 2 or 3 clicks counter-clockwise or turn the Mixture Control Screw 1-3 degrees counter-clockwise.
- Ⓠ Throttle response at hovering speeds is also affected by the relationship of the main rotor pitch angle to throttle opening. If the optimum mid-range throttle response cannot be obtained by the carburettor adjustments described above, try adjusting the helicopter's pitch control characteristics.

■ **SUBSEQUENT READJUSTMENTS**

Once the engine has been run-in and the carburetor controls properly set up, it should be unnecessary to alter the mixture settings, except to make minor adjustments to the Needle Valve occasionally, to take account of variations in climatic conditions.

The use of a different fuel, however, particularly one containing more, or less, nitromethane and / or a different type or proportion of lubricating oil, is likely to call for some readjustment of the Needle-Valve.

Remember that, as a safety measure, it is advisable to increase the Needle Valve opening by an extra half-turn counter-clockwise, prior to establishing a new setting. The same applies if the silencer type is changed. A different silencer may alter the exhaust pressure applied to the fuel feed and call for a revised Needle-Valve setting.

The use of a different glowplug, or changes to the mainrotor and its pitch angles may also require compensating carburetor readjustments.

■ **CARBURETOR CLEANLINESS**

The correct functioning of the carburetor depends on its small fuel orifices remaining clear. The minute particles of foreign matter that are present in any fuel can easily partially obstruct these orifices and upset mixture strength so that engine performance becomes erratic and unreliable. It is recommended that fuel is passed through a filter when the tank is filled and that a good in-line filter is installed between the fuel tank and carburetor and, furthermore, that this filter is frequently cleaned to remove foreign matter that accumulates on the filter screen. Finally, occasionally remove the needle-valve holder from the carburetor as shown in Photo and extract any remaining foreign matter that may have lodged in the location shown in Photo, right.

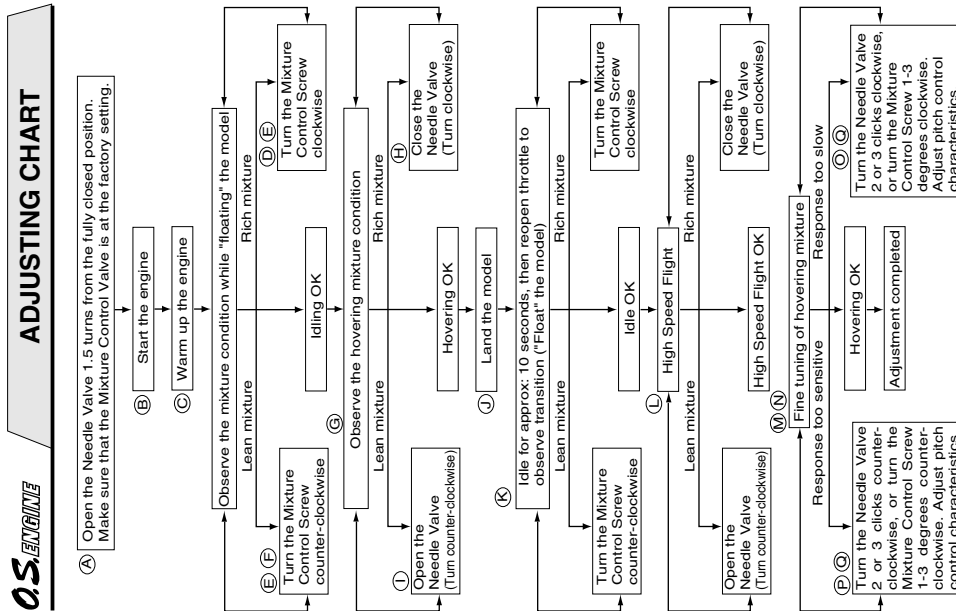
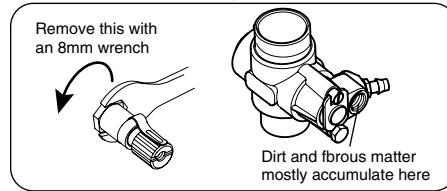

Please pay attention to the matters described below to ensure that your engine serves you well in regard to performance, reliability and long life.

- As previously mentioned, it is vitally important to avoid operating the engine in conditions where dust, disturbed by the propeller, may be deposited on the engine and enter its working parts.
- Remember to keep your fuel container closed to prevent foreign matter from contaminating the fuel.
- Install a fuel filter to prevent foreign matter in the fuel container from entering the fuel tank. O.S. Super Filters (L) and (S) are available as optional extras.
- Install an in-line fuel filter between the tank and carburetor to prevent foreign matter in the tank from entering the carburetor.
- Clean these filters periodically.
- If these precautions are neglected, restriction of fuel flow may cause the engine to cut out, or the fuel/air mixture to become too lean causing the engine to overheat.
- The use of modern high-performance alcohol based model engine fuels, while promoting cooler running, improved anti-detonation combustion and increased power, have the disadvantage of causing corrosion due to the acid by-products of combustion. The use of nitromethane in the fuel can also contribute to the problem.

- Do not close the needle-valve and mixture control valve too far as this will cause a lean setting and over heating of the engine. This can, in turn, create nitromethane oxide leading to internal rusting of the engine. Always adjust the needlevalve slightly on the rich side of peak rpm.
- Do not leave unused fuel in the engine at the conclusion of a day's flying. Accepted practice is to cut off the fuel supply while the engine is still running at full throttle, then expel as much fuel residue as possible by turning the engine over 5-10 seconds with the electric starter. Finally, inject some after-run oil through the glowplug hole and turn the engine over several times by hand.
- When the engine is not to be used for some months (for example, as between flying seasons), a worthwhile precaution is to remove it from the airframe and, after washing off the exterior with alcohol (not gasoline nor kerosene), remove carefully the carburetor with intake pipe, glow plug and all silicone tubing and put them safely aside. Then, immerse the engine in a container of alcohol. Rotate the crankshaft while the engine is immersed. If foreign matter is visible in the alcohol, rinse the engine again in clean alcohol. Finally, shake off and dry the alcohol, and inject some after-run oil in the glowplug hole and rotate the crankshaft several times by hand. Reinstall the carburetor with intake pipe and glowplug on the engine and keep it in a dry place after putting in a vinyl bag.

Symptom	
Engine fails to fire.	
Cause	Corrective action
Fuel tank is empty. Fuel not reaching the engine.	Fill the tank with fuel and repeat. Priming procedure.
Glowplug element is burnt out. Glowplug battery discharged	Replace glowplug. Recharge or replace the battery.
Clogged fuel filter. Silencer inside is dirty.	Clean or replace fuel filter. Clean inside silencer.
Over priming	Remove glowplug and pump out excess fuel.
Fuel tubing is disconnected. Fuel tubing is kinked, split or has a hole.	Connect fuel tubing securely. Check the tubing carefully and replace if necessary.
Incorrect carburetor settings	Return the needle valve and mixture control valve to basic position.
Incorrect servo linkage	Reconnect linkage after setting servo at neutral.
Reverse rotating direction of electric starter.	Make sure the engine rotates counter clockwise seen from crankshaft side.

Symptom	
Engine fires intermittently but does not run.	
Cause	Corrective action
Insufficient fuel in the tank.	Fill the tank with fuel.
Deteriorated glowplug	Replace glowplug.
Clogged fuel filter Silencer inside is dirty.	Clean or replace fuel filter. Clean inside silencer.
Engine overheated	Wait until engine has cooled.
Disconnecting plug battery too soon.	Do not disconnect plug battery and wait until the r.p.m. becomes stable.
Air bubbles in fuel	Fit O rings to the tank screws to prevent bubbles.

Symptom	
Unstable idle	
Cause	Corrective action
Unsuitable glowplug	Use suggested glowplug in the instructions.
Unsuitable fuel	Do not use extremely high nitro or low oil fuel.
Silencer is disconnected or is loose	Install silencer securely.
Symptom	
Not reaching expected peak r.p.m.	
Cause	Corrective action
Insufficient warming up or running-in.	Set the needle only after warming up. Complete running-in.
Silencer or manifold is not securely connected or disconnected.	Check the connections and secure them.
Fuel tubing from tank to is split or broken.	Replace the tubing.

Symptom	
Poor response	
Cause	Corrective action
Deteriorated glowplug	Replace glowplug.
Incorrect carburetor settings	Readjust low r.p.m. range with metering needle and mixture control valve.
Inaccurate linkage	Recheck the throttle opening against the pitch angle.
Symptom	
Poor r.p.m. drop	
Cause	Corrective action
Too much throttle opening at idle.	Lower the throttle trim to adequate position to lower idle r.p.m.
Incorrect carburetor fitting	Fit carburetor securely.
Needle-valve closed too far.	Open needle-valve slightly

No.	Code No.	Description
1	25204200	Hyper Head
2	25203100	Cylinder Liner
3	25303400	Piston Ring
4	25203200	Piston
5	25206000	Piston Pin
6	25217000	Piston Pin Retainer (2pcs.)
7	25205000	Connecting Rod
8	29083020	Carburetor Complete (Type 60LH)
9	23210007	Propeller Nut
10	46120000	Thrust Washer
11	26731002	Crankshaft Bearing (Front)
12	23981700	Carburetor Retainer Assembly
13	25201000	Crankcase
14	25830000	Crankshaft Bearing (Rear)
15	25202000	Crankshaft
16	25214000	Gasket Set
17	25207001	Cover Plate
18	25613000	Screw Set
	71608001	Glow Plug No.8

The specifications are subject to alteration for improvement without notice.

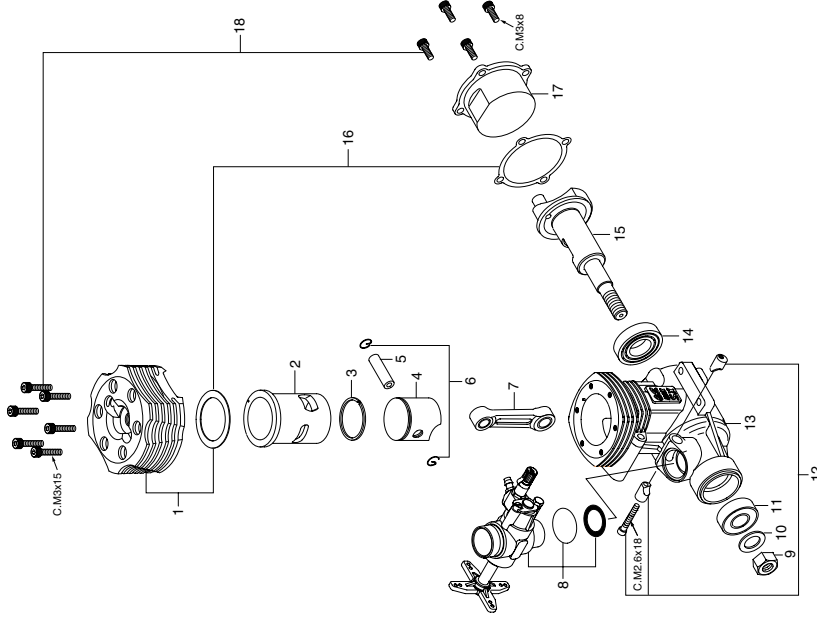

* Type of screw
C...Cap Screw

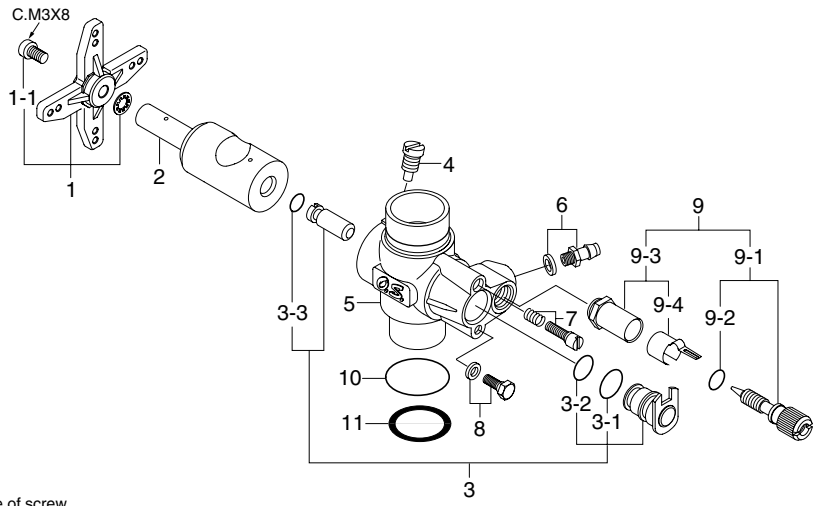



* Type of screw
C...Cap Screw

No.	Code No.	Description
1	29085140	Throttle Lever Assembly
1-1	22826131	Throttle Lever Retaining Screw
2	29083200	Carburetor Rotor
3	29083600	Mixture Control Valve Assembly
3-1	27881810	"O" Ring (L) (2pcs.)
3-2	27881800	"O" Ring (S) (2pcs.)
3-3	27881820	"O" Ring (L) (2pcs.)
4	45581820	Rotor Guide Screw
5	29083110	Carburetor Body
6	22681953	Fuel Inlet (No.1)
7	27881330	Mixture Control Screw
8	27681340	Mixture Control Valve Stopper Assembly
9	27981900	Needle Valve Assembly
9-1	27981910	Needle Assembly
9-2	24981837	"O" Ring (2pcs.)
9-3	27381940	Needle Valve Holder Assembly
9-4	26711305	Ratchet Spring
10	29015019	Carburetor Rubber Gasket
11	23818190	Carburetor Sealing Washer

The specifications are subject to alteration for improvement without notice.

■ **GLOWPLUG**

- **No.7**
(71607100) 
- **No.8**
(71608001) 
- **No.10 (Former A5)**
(71605100)

■ **POWER BOOST Pipe 55**
(72144000)

- M3x35 Cap Screw (2pcs.)
- Spring Washer (2pcs.)
- Nipple (1pc)

■ **EXHAUST GASKET SET**

- 55HZ (3pcs.)**
(72144040)

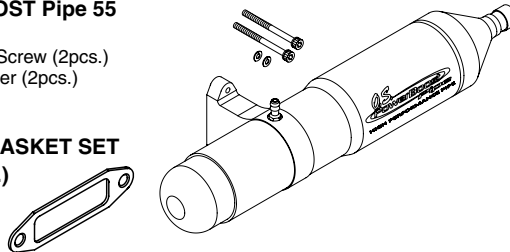

■ **SUPER FILTER (L)** (72403050)



■ **NON-BUBBLE WEIGHT**
(71531000)



■ **NON-BUBBLE WEIGHT S**
(71531010)



■ **LOCK WASHER (10set) M3**
(55500002)



■ **CRANKSHAFT CLAMP 3246** (71530400)

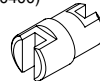

■ **LONG SOCKET WRENCH WITH PLUG GRIP**
(71521000)

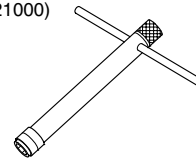

The specifications are subject to alteration for improvement without notice.

SPECIFICATIONS

■ Displacement	8.17 cc (0.499 cu.in.)
■ Bore	22.0mm (0.866 in.)
■ Stroke	21.5mm (0.847 in.)
■ Practical R.P.M.	2,000-20,000 r.p.m.
■ Power output	1.9 ps / 1.93 hp / 17,000 r.p.m.
■ Weight	406g (14.33 oz.)

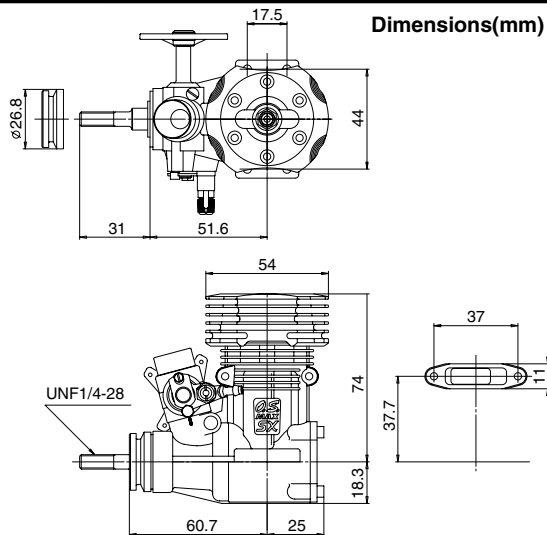

NOTE: Please note that this engine is not supplied with Drive Hub.

.....

.....

.....

.....

.....

.....

.....

.....

.....

.....

.....



O.S. ENGINES MFG. CO., LTD.
URL : <http://www.os-engines.co.jp>

6-15 3-Chome Imagawa Higashisumiyoshi-ku
Osaka 546-0003, Japan TEL. (06) 6702-0225
FAX. (06) 6704-2722